

# '69 FORD BRONCO

ALL-PURPOSE 4-WHEEL-DRIVE VEHICLES





## Bronco's the surefooted way to get wherever you want to go

Bronco's built to go . . . through snow, mud or shifting sands, up ground that's too rough for anything but the toughest. Bronco's four-wheel drive gives you the traction! Big Six or V-8 engines give you the power! Underneath, Bronco has lots of ground clearance and a tough, protected underside. Wide-track Mono-Beam front suspension makes Bronco stable on hillsides, smooth riding, and easy handling no matter where you go for work or play!

**Bronco Wagon** has an all-steel full roof. New, strategically placed reinforcements in roof and body structure provide greater strength, keep body and doors

tight. Sturdy doors have big rectangular windows that crank up and down and triangular vent windows that pivot for excellent ventilation. Fixed windows in rear liftgate and on each side of the rear compartment allow fine all-round visibility. Choose either the standard or Sport Bronco Wagon.

**Bronco Pickup** is similar to the wagon, except for its short roof with fixed rear window and open cargo box. As with the wagon, the tailgate is a full 56 inches wide and has a convenient one-hand latch. The pickup's cargo box packs over 32 cubic feet of loadspace. Sport Bronco Pickup is available.

**Bronco has plenty of power** to storm hills, pull trailers, and plow deep drifts. Big 170-cu. in. Six is standard for sure power with outstanding economy. Better than ever, the new optional 302-cu. in. V-8 puts 205 surging horses under the hood! Both are America's most powerful engines in their class for this type vehicle, and are equipped for steep grades with special carburetor and fuel pump. Bronco really has the horses to keep you ahead on both trails and turnpikes.



Sport Bronco Wagon

Bronco Pickup

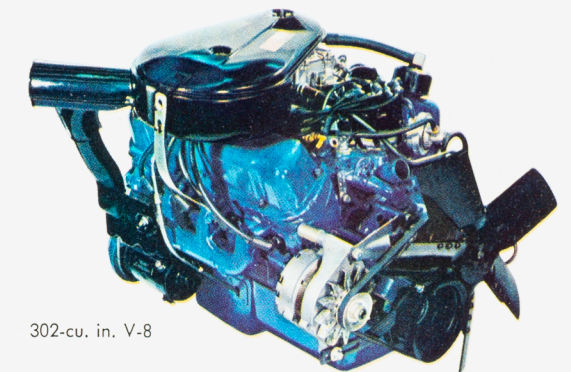

302-cu. in. V-8

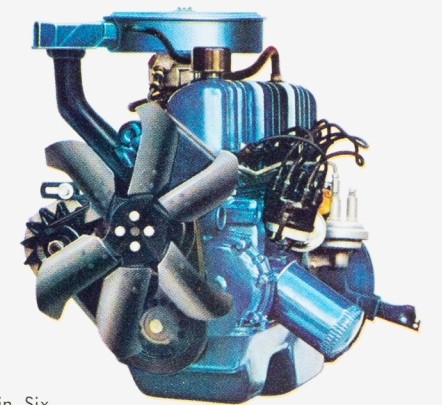

170-cu. in. Six



**Rugged Broncos** take you any place business calls. Ride right up to the toughest construction site or lead the way surveying. Broncos make excellent "command cars" and versatile utility and service vehicles.

Install power take-off, winch, battery cables, and Bronco is a great gas station emergency vehicle. Add or remove a snowplow in no time flat; blade height may be adjusted from inside cab, kit for blade angle control is available.

**6000-mile maintenance schedule** for chassis lube, oil and oil filter change, and air cleaner service. Consult your Ford Dealer for full service information.

Engine specifications	170-cu. in. Six (standard)	302-cu. in. V-8 (2V) (optional)
Max. Gross HP @ RPM	100 @ 4000	205 @ 4600
Max. Gross Torque (lbs-ft)	156 @ 2200	300 @ 2600
Bore and Stroke (in.)	3.5 x 2.94	4.0 x 3.0
Compression Ratio	8.7 to 1	8.6 to 1



## Exclusive Mono-Beam suspension flattens rough trails and lets you cruise smoothly on highways

Bronco's Mono-Beam front suspension provides the finest ride of any vehicle of its type . . . combined with the greatest cross-

country durability and maneuverability. Rugged, resilient coil springs and sturdy forged-steel radius rods, attached to the axle and frame through shock-absorbing rubber insulators, are built to take it . . . and take the bumps, too! A forged-steel track bar extending across the front provides lateral stability.

Bronco's strong, proven front axle design virtually eliminates wheel shimmy. Kingpins feature high-density polyurethane filled bearing caps that compensate for wear . . . prolong the life of kingpin bearings. A special steering-linkage shock absorber is standard for added protection against severe jolts in off-road operations.

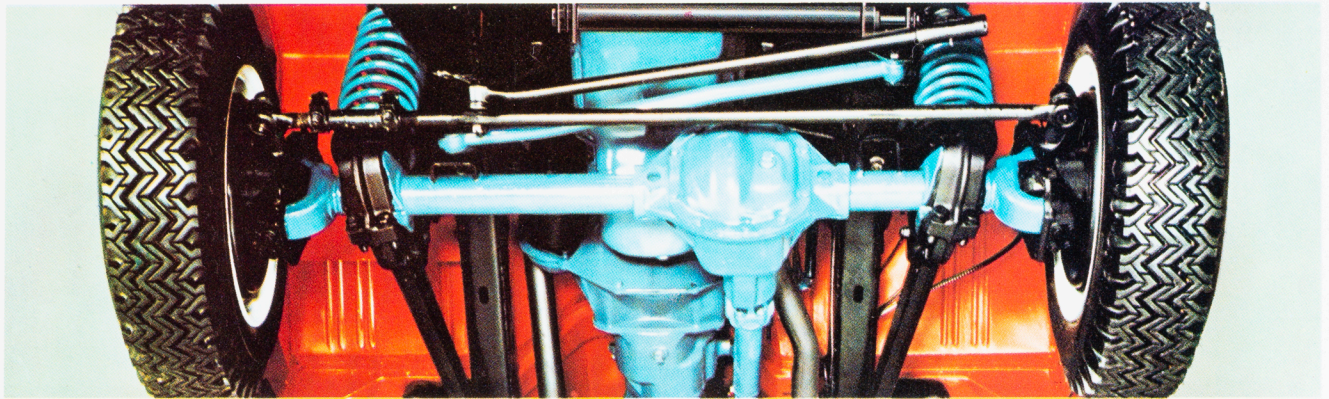

**Wide-track stability** . . . Bronco has the widest track in its class (57.4-inch) for both front and rear axles. Bronco has less side sway on the highway . . . provides trail-hugging stability on hillsides.

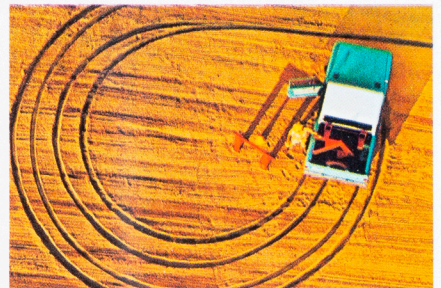

**Sharp-turning maneuverability** . . . wide-track front axle with 37° turn angle lets Bronco turn in a small 33.6-foot circle . . . sharper than any other vehicle in its class.

**Off-road brute strength!** Bronco is rugged all-the-way through with an all-welded box-section frame, forged-steel radius rods, high-capacity axles, channel bumpers, and big brakes. And for '69, Bronco features additional strength in side rocker panels, door frames, floor pillar junctions, and stronger door hinges. New body sealing keeps out dust and road splash. Bronco's fully synchronized 3-speed transmission allows you to downshift into first gear without gear clash and maintain momentum through mud holes or snow banks.

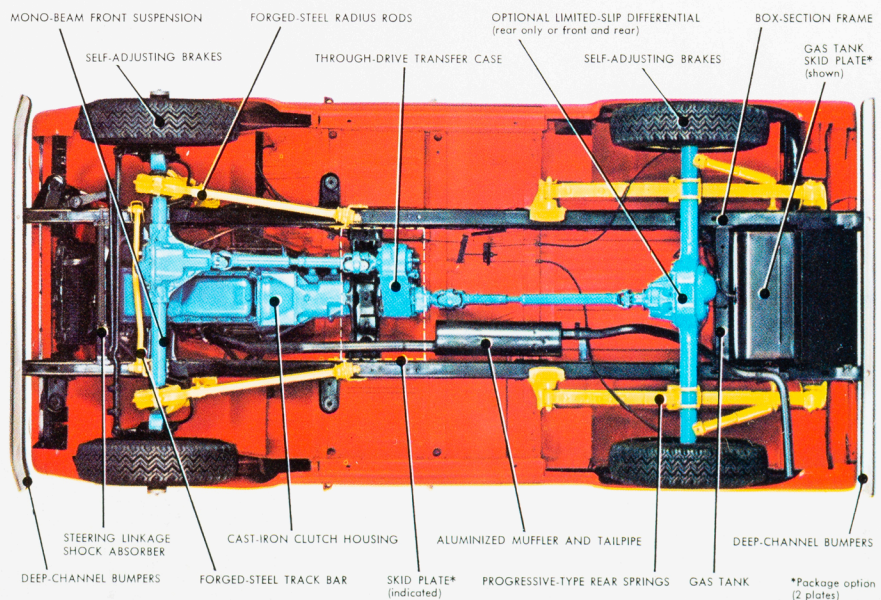



# Choose your own brand of comfort with a Ford Bronco

Bronco combines solid strength with surefire comfort, convenience and utility. The attractive interior is roomy and uncluttered. Handsome all-vinyl, full-width front seat,

fresh air heater and defroster, lockable glove compartment, padded dash, energy-absorbing sun visors and rubber-coated vinyl front floor mat are all standard. Special Sport models are available for both Bronco Wagons and Pickups.

Body design and suspended foot pedals help seal out noise, dust and road splash. Eight strategically located rubber-cushion body

mounts soak up ground shock and vibration for a softer, quieter ride.

Bronco's convenient transmission shift lever is in the familiar steering-column location. Simple, floor-mounted T-bar transfer case control allows shifting into 4-wheel direct drive without stopping or clutching. And positive-lock design helps prevent accidental jumping out of 4-wheel drive.



Sport Bronco interior

(Roofs have been removed on Broncos illustrated below to show seating arrangements)



**Front full-width seat.** A spacious, three-passenger seat is standard on all Broncos. Upholstered in attractive all-vinyl, the seat has a travel adjustment of five inches.



**Front bucket seats.** For extra comfort and sports flair, you can select pleated-vinyl bucket seats. Bucket seat option also includes outboard seat-belt retractors.



**Bucket seats plus rear seat.** With front buckets you can also have a matching pleated-vinyl, two-passenger rear seat with integral arm rests on Bronco Wagons.

## SPORT BRONCOS . . . WAGON AND PICKUP

Sport Bronco Wagon and Pickup features, in addition to or in place of standard features, include: Bright-metal "Sport Bronco" emblem • Pleated parchment vinyl front seat • Vinyl door trim panels with bright-metal moldings • Hardboard headlining with bright-metal retainer moldings (Wagon models) • Parchment vinyl simulated-carpet front floor mat with bright-metal retainers • Rear floor mat is included

with optional rear seat • Cigarette lighter • Satin-finish horn ring • Bright-metal drip rail moldings • Bright-metal windshield and window frames • Bright-metal grille molding, headlight and taillight bezels, tailgate release handle • Argent-painted grille • Chrome bumpers, front and rear • Chrome front bumper guards • Bright-metal wheel covers (with 15-in. wheels only).



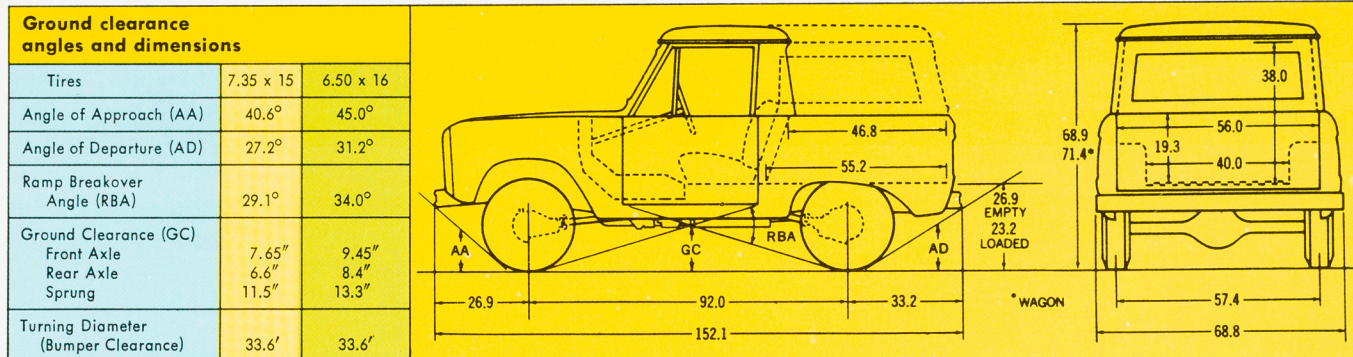

Equipment	Standard	Optional
<b>Alternator:</b>	38 amp.	55 amp.
<b>Axle, Front:</b> Capacity (lb.)—Ratio (to 1)	2500—4.10	Limited-slip <sup>†</sup>
<b>Axle, Rear:</b> Capacity (lb.)—Ratio (to 1)	2780—4.11	2780—3.50, 4.57; 3300*—3.50, 4.11
Ratios for 2780 and 3300 Limited-slip		3.50, 4.11
<b>Battery:</b> (12 volts)	54 plates, 45 amp-hr.	66 plates, 70 amp-hr
<b>Brakes, Service:</b> Dual hydraulic system	Self-adjusting	
Size (in.) front	11 x 2	
rear	10 x 2½	
<b>Brakes, Parking:</b> Type	Cable actuation of rear brakes	
<b>Clutch:</b> Dia. (in.)	9¾ w/Six, 11 w/V-8	
<b>Engine:</b>	170-cu. in. Six	302-cu. in. V-8
<b>Frame:</b> Section Modulus	2.04	
<b>Hubs, Front:</b>		Free-running
<b>Shock Absorbers:</b> Front and rear	Double-acting	
<b>Springs, Front:</b> Coil, Capacity @ pad (lb. ea.)	750 w/Six, 800 w/V-8	850, 1000
<b>Springs, Rear:</b> Capacity @ pad (lb. ea.)	Progressive 930	Progressive 1280
<b>Steering:</b>	Gemmer worm & roller w/linkage shock absorber	
<b>Tank, Fuel:</b>	14.5 gal.	11.5 gal. auxiliary with skid plate
<b>Transfer Case:</b> Constant mesh, Dana 20	2-spd. thru-drive	
<b>Transmission:</b> Fully synchronized, Ford	3-spd. direct	
<b>Wheels:</b> No.—type—rim size (in.)	5—5-hole disc—5½K	5—5-hole disc—5K**
<b>Tires:</b> (load range)	Tubeless 7.35 x 15 B†	Tube-type 6.50 x 16 6PR TT**
<b>Color Choices:</b> Raven Black, Wimbledon White, Candyapple Red, Royal Maroon, Reef Aqua, Sky View Blue, Harbor Blue, Pebble Beige, Lunar Green, Norway Green, Boxwood Green, New Lime, Cordova Copper, Empire Yellow and Chrome Yellow. Bronco metal roofs are painted Wimbledon White providing a two-tone paint combination.		

\*Includes 11" x 1¼" rear brakes. \*\*Provides maximum ground clearance and durability. Other tire sizes also available. For high flotation tire sizes see your Ford Dealer. †—Passenger type=4PR  
 TT=Truck type. \*Requires free-running hubs and limited-slip rear axle.  
 Note: With standard equipment, Bronco has a GVW rating of 3,900 lb. A special 4700-lb. GVW package may be purchased as a unit. This package includes a Ford 3300-lb. capacity rear axle with 11" x 1¼" rear brakes, 1280-lb. rear springs and 8.25 x 15 load range D 8PR tubeless tires.

**Custom-Tailoring Options:** Convenience Group (cigarette lighter,\* map light, inside day/night mirror, horn ring\*) • One-pint oil-bath air cleaner (302 V-8 only) • Right-hand chrome rearview mirror • Bucket seats • Rear seat (Wagon w/bucket seat option) • Chrome bumpers\* • Skid plates for std. fuel tank and transfer case • Inside tailgate-mounted tire carrier (incl. with rear seat option) • Exterior rear-mounted swing-away tire carrier • Bright-metal wheel covers (15-inch wheels only)\* • High-flotation tires • Auxiliary 11½-gal. fuel tank with skid plate • Manual radio and antenna • Bright body side and tailgate molding • Bright-metal rocker panel molding • Reflectors, front • Dana free-running front hubs (manual) • Hand-operated throttle • Heavy-duty front axle carrier assembly is available by special order.

**Dealer-Installed Accessories:** Chrome inside hand-rails • Power take-off (front-mounted) • Warn free-running front hubs (manual or automatic) • Snowplows • Snowplow angling kits • Front auxiliary air springs • Front-mounted winch • Trailer hitch • Trailer towing mirror • Locking gas caps • Front tow hooks (2).

\*Standard on Sport models



**Snowplow Blade** may be adjusted to various heights and angles (with kit) from inside the cab.

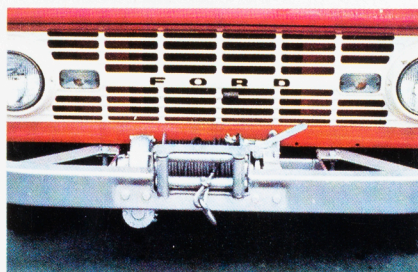

**Front-Mounted Winch** with 150 feet of 5/16-inch cable is power take-off driven.



**Swing-Away Spare Tire Carrier** gets the tire out of the way for more cargo area, easier access.

Specifications, descriptions and illustrative material contained herein were as accurate as known at the time this publication was approved for printing. The Ford Division, Ford Motor Company reserves the right to discontinue models at any time or change specifications or design without notice and without incurring obligation. Specifications are applicable to units sold in the United States, its territories and possessions and may vary outside these areas. Some of the vehicle colors and paint combinations illustrated are special order options only. All options and accessories illustrated or referred to as optional or available in this publication are at extra cost. For the price of the model with the equipment you desire or verification of specifications contained herein, see your Ford Dealer.

**FORD BRONCO** 